

# FLAT TOP TOWER CRANE



**Specifications:**

- ▶ Max jib length: 65,00 m
- ▶ Capacity at max length: 2,00 t
- ▶ Max capacity: 8,00 t

**WORKS FOR YOU.™**

# KEY

## Zeichenerklärung · Légende · Leyenda · Legenda · Legenda · Условные обозначения



Hoisting · Heben · Levage · Elevación · Sollevamento · Elevação · Подъем



Trolleying · Katzfahren · Distribution · Distribución · Traslazione carrello · Distribuição · Передвижение каретки



Slewing · Schwenken · Orientation · Orientació · Rotazione · Giro · Поворот



Travelling · Schienenfahren · Translation · Traslación · Traslazione · Móvel · Передвижение



Directive on noise level · Richtlinie für den Schall-Leistungspegel · Directive sur le niveau acoustique · Directiva sobre el nivel acústico ·  
Direttiva sul livello acustico · Diretiva sobre nível de ruídos · Директива по уровню шума



Consult us · Auf Anfrage · Nous consulter · Consultarnos · Consultateci · Consulte-nos · Проконсультироваться с нами



Power requirements · Geforderte Stromstärke · Puissance totale nécessaire · Potencia necesaria · Potenza totale richiesta ·  
Requisitos de energia · Требования по питанию



Power supply · Stromversorgung · Alimentation · Alimentación · Alimentazione · Fonte de alimentação · Питание



In service · In Betrieb · En service · En servicio · In servizio · Em serviço · При работе



Out of service · Außer Betrieb · Hors service · Fuera de servicio · Fuori servizio · Fora de serviço · В режиме простоя



Max. under hook height · Höchste Hakenhöhe · Hauteur maxi. sous crochet · Maxima altura bajo gancho ·  
Altezza max. sotto gancio · Alt. máx. sob o gancho · Макс высота крюка



Without load, without ballast, max. jib and max. height · Ohne Last und Ballast, mit Maximalausleger und Maximalhöhe ·  
A vide, sans lest, avec flèche et hauteur maximum · Sin carga, sin lastre, con pluma y altura máxima · A vuoto, senza zavorra,  
braccio max., altezza max. · Sem carga, sem lastro, lança máxima, altura máxima · Без груза, без балласта, на макс.  
Длине вспомогательной стрелы и макс. Высоте



Counterweight · Gegengewicht · Lest de contre-flèche · Lastre de contra flecha · Zavorra controbraccio · Contrapeso ·  
Противовес

### C25

EN 14439-C25 out of service proof with LC1 & LC3 - wind coming from each side 100 Km/h - For different requirement please  
contact us · EN 14439 - C25 außer Betrieb mit LC1 & LC3 - Wind von jeder Seite 100 km/h - für abweichende Anforderungen  
kontaktieren Sie uns bitte · EN14439 - C25 hors service avec LC1 & LC3 - vent 100km/h de chaque côté · Nous contacter  
pour des caractéristiques différentes · EN 14439 - C25 fuera de servicio con LC1 & LC3 - viento de cada lado 100 km/h -  
contáctenos si necesita más información · EN 14439 - C25 fuori servizio con LC1 & LC 3 - vento in ogni direzione 100 km/h  
- contattateci per differenti richieste · EN 14439 - C25 fora de serviço com LC1 e LC3 - vento de cada lado 100 kmh - para  
pedidos especiais, entre em contato conosco · EN14439 - C25 не совместим с LC1 & LC3 - ветровая нагрузка не более  
100км/ч - для уточнения спецификаций обращайтесь, пожалуйста, к нам

# CONTENTS

СТТ 182-8

Inhalt · Contenu · Contenido · Indice · Sumário · Содержание

Page · Seite · Page · Página · Pagina · Página · Страница:

Load Diagram · Lastkurven · Courbes de charges · Curvas de cargas · Diagramma di portata · Diagrama de carga · Диаграмма грузоподъёмности .....	4
Tower · Turm · Tour · Torre · Torre · Torre · Башня .....	6
Mechanisms · Antriebe · Mécanismes · Mecanismos · Meccanismi · Mecanismo · Механизм .....	9
Transportation · Transport · Transport · Transporte · Trasporto · Transporte · Транспортировка .....	10

# LOAD DIAGRAM

Lastkurven · Courbes de charges · Curvas de cargas · Diagramma di portata · Diagrama de carga · Диаграмма грузоподъёмности

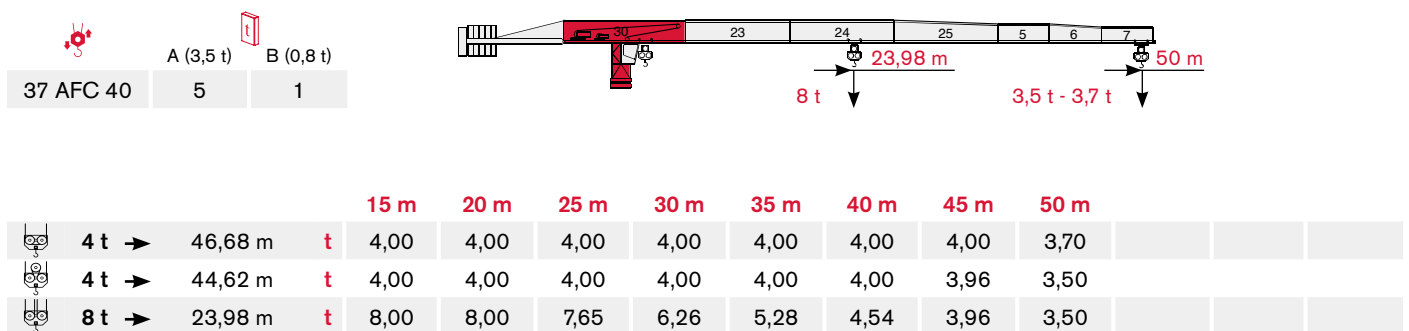
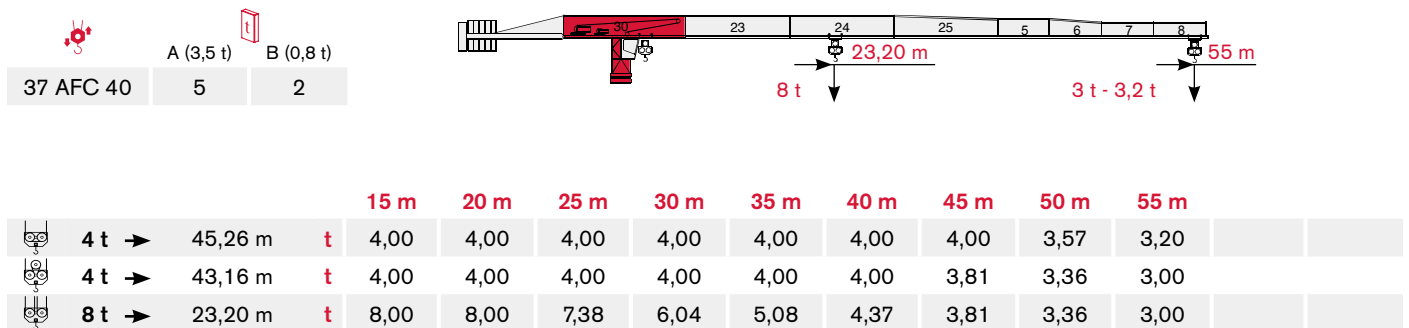
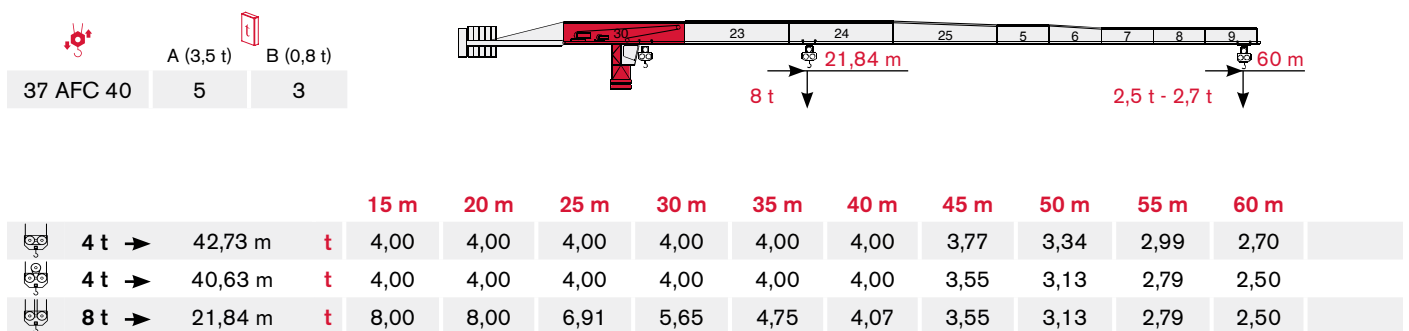
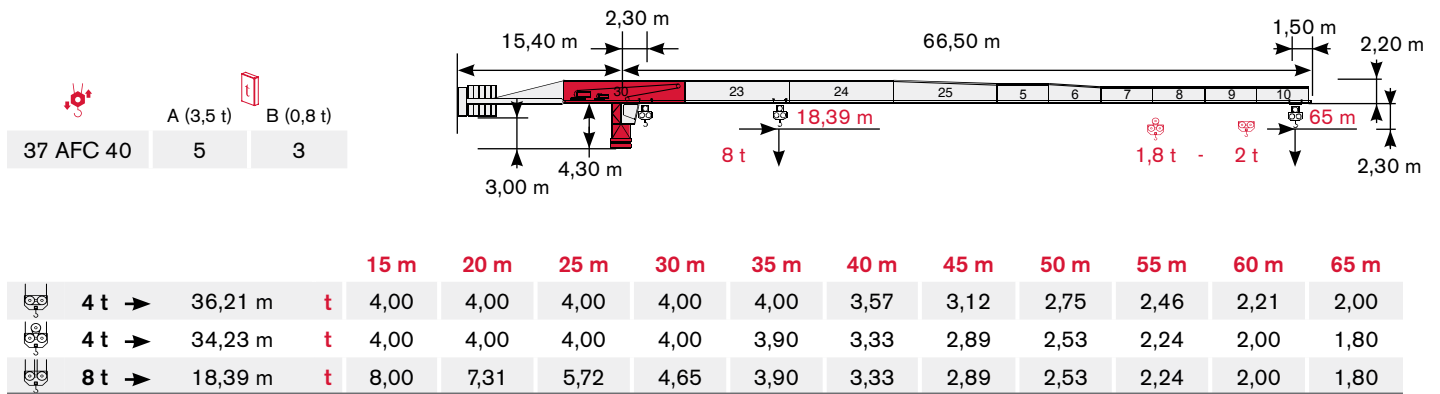

37 AFC 40	A (3,5 t)	B (0,8 t)
	4	4

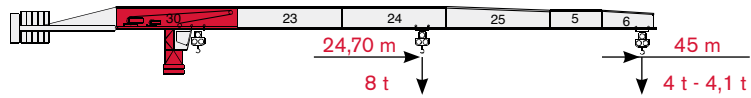

			15 m	20 m	25 m	30 m	35 m	40 m	45 m				
	4 t →	45,00 m	t	4,00	4,00	4,00	4,00	4,00	4,00	4,00			
	4 t →	45,00 m	t	4,00	4,00	4,00	4,00	4,00	4,00	4,00			
	8 t →	24,70 m	t	8,00	8,00	7,90	6,47	5,50	4,69	4,10			

37 AFC 40	A (3,5 t)	B (0,8 t)
	4	2

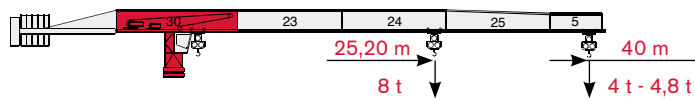

			15 m	20 m	25 m	30 m	35 m	40 m				
	4 t →	40,00 m	t	4,00	4,00	4,00	4,00	4,00	4,00			
	4 t →	40,00 m	t	4,00	4,00	4,00	4,00	4,00	4,00			
	8 t →	25,20 m	t	8,00	8,00	8,00	6,62	5,60	4,80			

37 AFC 40	A (3,5 t)	B (0,8 t)
	4	1

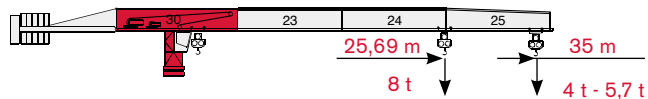

			15 m	20 m	25 m	30 m	35 m					
	4 t →	35,00 m	t	4,00	4,00	4,00	4,00	4,00				
	4 t →	35,00 m	t	4,00	4,00	4,00	4,00	4,00				
	8 t →	25,69 m	t	8,00	8,00	8,00	6,76	5,70				

# TOWER

Turn · Tour · Torre · Torre · Torre · Башня

Standard Configurations · Standardkonfiguration · Standard Implantations ·  
 Implantaciones Standard · Installazioni Standard · Configuração padrão ·  
 Стандартная конфигурация крана

## TS21

Tower: TS21 & Basement: R3

	●	◊
R1	-1570 kN	-2267 kN
R2	-1127 kN	1873 kN
	593 kN	

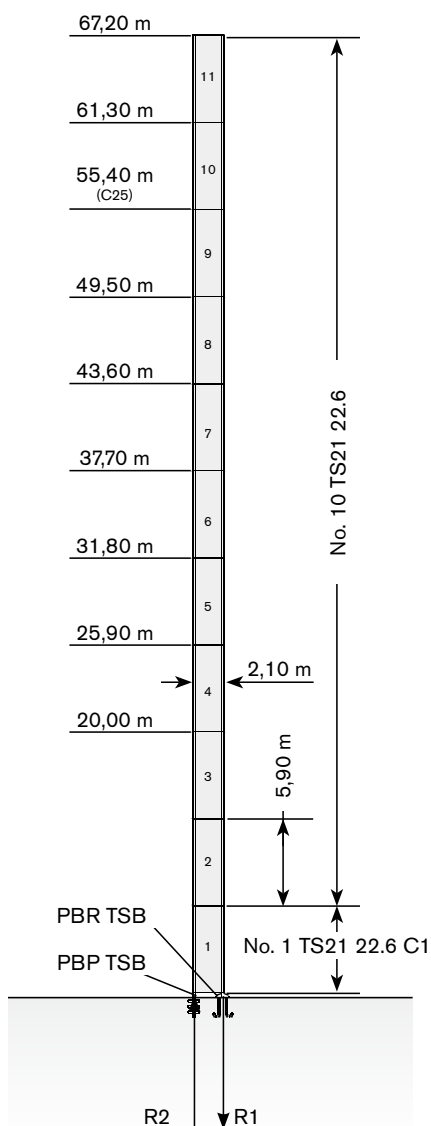

Tower: TS21 & Basement: FP3

	●	◊
R1	-798 kN	-1035 kN
R2	0 kN	0 kN
	627 kN	

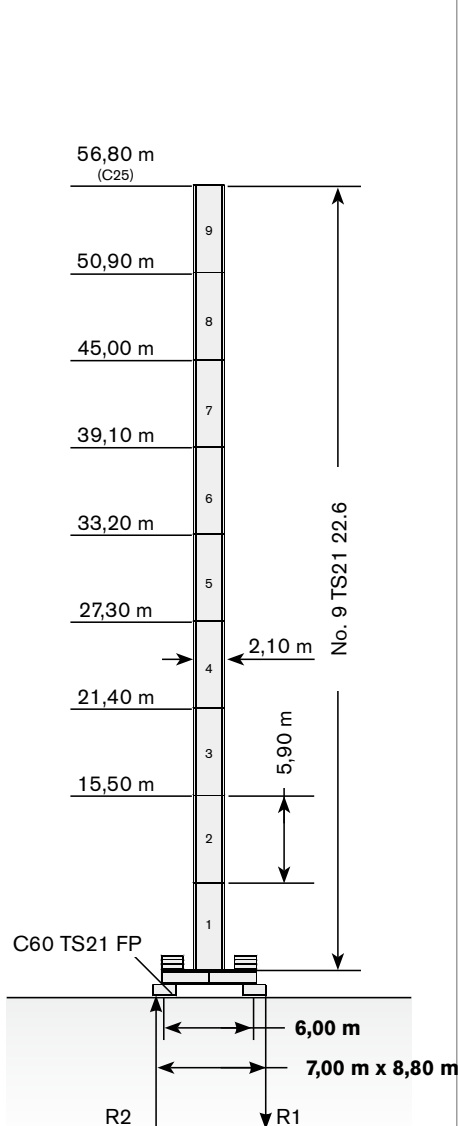

Tower: TS21 & Basement: T3

	●	◊
R1	-881 kN	-1035 kN
R2	0 kN	0 kN
	667 kN	

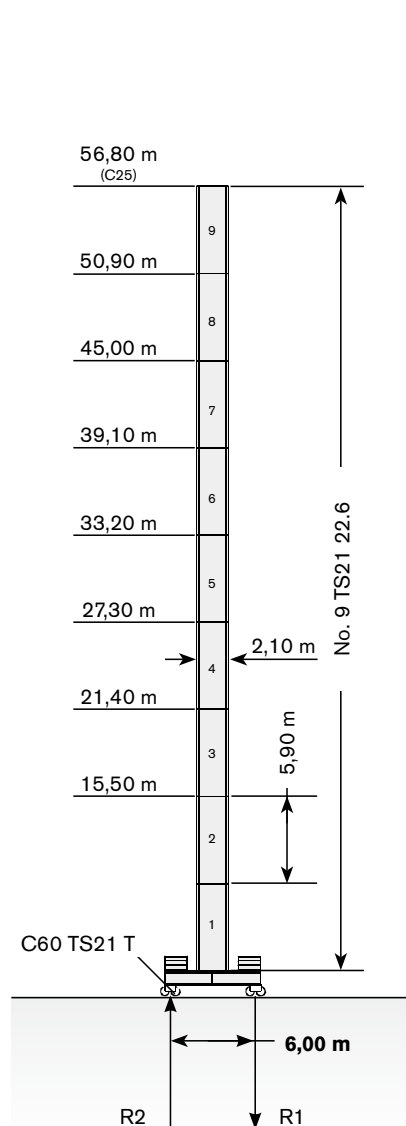

Max. under hook height · Höchste Hakenhöhe · Hauteur maxi. sous crochet · Maxima altura bajo gancho · Altezza max. sotto gancio ·  
 Alt. máx. sob o gancho · Макс высота крюка

**Tower: TS21 & Basement: F4**

	●	◊
<b>R1</b>	-832 kN	-795 kN
<b>R2</b>	-13 kN	0 kN
	544 kN	

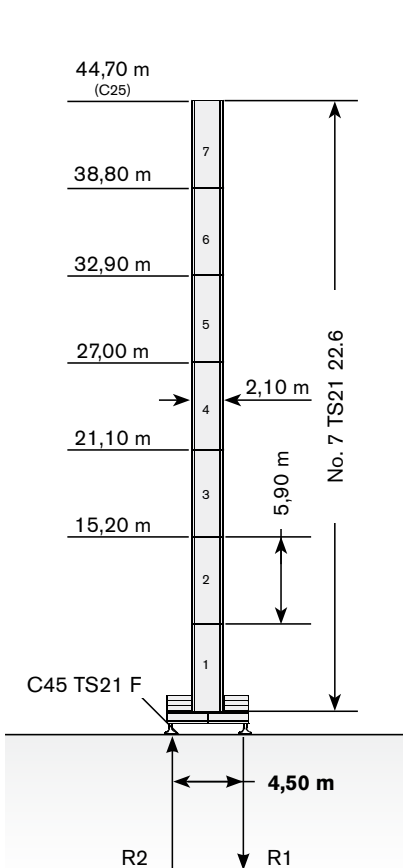

**Tower: TS21 & Basement: FP4**

	●	◊
<b>R1</b>	-870 kN	-926 kN
<b>R2</b>	-24 kN	0 kN
	558 kN	

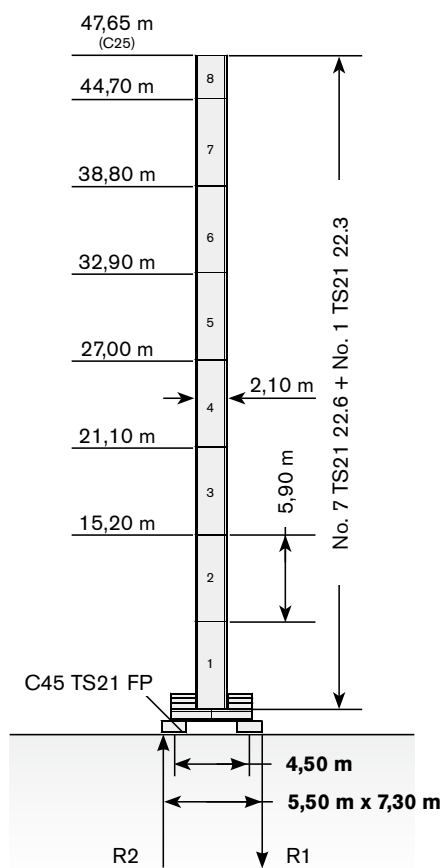

**Tower: TS21 & Basement: T4**

	●	◊
<b>R1</b>	-933 kN	-795 kN
<b>R2</b>	0 kN	0 kN
	584 kN	

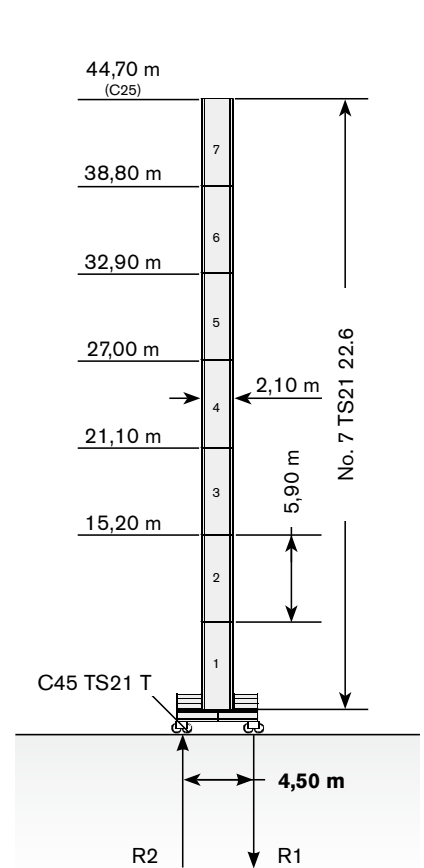

The available lengths for the TS tower sections are 11.8 m, 5.9 m, 2.95 m. · Die Turmschüsse TS sind mit Längen 11.8 m, 5.9 m, 2.95 m verfügbar. · Les éléments de mât TS sont disponibles en longueur 11.8 m, 5.9 m, 2.95 m. · Los tramos de torre TS son disponibles en las medidas de largo 11.8 m, 5.9 m, 2.95 m. · Le prolunghe TS sono disponibili in lunghezze 11.8 m, 5.9 m, 2.95 m. · Os comprimentos disponíveis para elementos de torre TS são: 11.8m, 5.9m e 2.95m. · Длина поставляемых секций башни TS - 11.8 м, 5.9 м, 2.95 м.

# TOWER

**Turm · Tour · Torre · Torre · Torre · Башня**

**Other configurations · Aufstellmöglichkeiten · Autres Implantations ·  
Otras Implantaciones · Altre Installazioni · Outras configurações ·  
Другие конфигурации**

Bottom climbing crane · Kletterkran im Gebäude · Télescopage sur dalles · Telescopage grúa trepadora · Gru climbing · Guindaste automontante interno · Самоподъемный кран

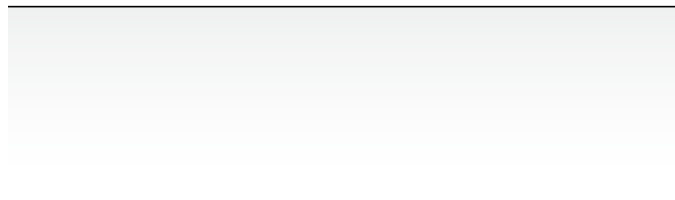
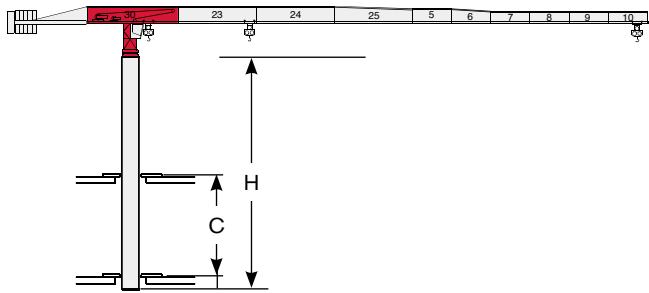

	min	max
<b>C</b>	11,00 m	14,00 m
<b>H</b>	29,50 m	41,30 m

Crane tied to the structure · Geankerter Kran · Grue ancrée · Grúa anclada · Gru ancorata · Guindaste ancorado na estrutura · Кран, крепящийся к сооружению

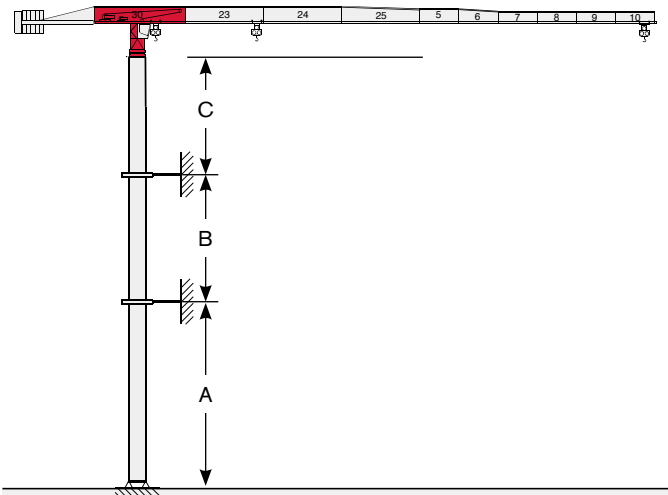

	min	max
<b>A</b>	42,00 m	54,00 m
<b>B</b>	17,70 m	23,60 m
<b>C</b>	29,00 m	



Different heights and tower combinations are available; please consult us · Andere Höhen und Turmkombinationen auf Anfrage · Différentes hauteurs et combinaisons de tour sont disponibles; nous consulter · Hay diferentes alturas y combinaciones de torre disponibles. Consultenos · Altezze diverse e combinazioni di torre sono disponibili; consultateci · Diferentes alturas e combinações de torres disponíveis; fale conosco · Возможны другие сочетания высоты и конфигурации башни; проконсультируйтесь с нами



# MECHANISMS

CTT 182-8

Antriebe · Mécanismes · Mecanismos · Meccanismi · Mecanismo · Механизм

Power supply · Stromversorgung · Alimentation · Suministro eléctrico · Alimentazione · Requisitos de energia · Требования по питанию

	37 AFC 40	59 kVA*	400V - 50Hz / 460V - 60Hz	2000/14/CE modificata
--	-----------	---------	---------------------------	-----------------------

\* Average consumption · Durchschnittsverbrauch · Consommation moyenne · Consumo medio · Consumo medio · Consumo médio · Среднее потребление

Hoisting · Heben · Levage · Elevación · Sollevamento · Elevação · Подъем

			t	m/min	kW	
	37 AFC 40 (Variant)		4	0 → 44	37	 510 m max 255 m
			3	0 → 57		
			2	0 → 82		
			1,5	0 → 105		
			1	0 → 132		
			8	0 → 22		
			6	0 → 28		
			4	0 → 41		
			3	0 → 52		
			2	0 → 66		

Hoisting Speed · Heben Geschwindigkeit · Vitesse de Levage · Velocidad de Elevación · Velocità di Sollevamento · Velocidade de içamento · Скорость подъема

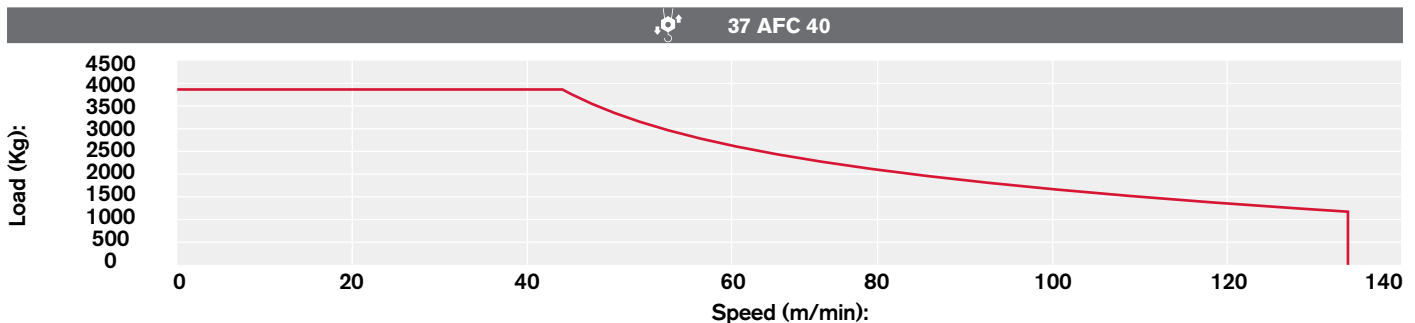

Additional Specifications · Weitere Leistungsdaten · Spécifications additionnelles · Otras prestaciones · Altre movimentazioni · Especificações adicionais · Дополнительные спецификации

	DVF 3 4 D7	0 → 6 → 32 → 64 m/min	4 kW
	SVF 2 2 6	0.7 r.p.m	2 x 5.5 kW
	TAD 2RP 2M4	0 → 24 m/min	2 x 4 kW
	TAD 2RG 4M3	0 → 24 m/min	4 x 3 kW

Tower height max.



		T3	T4
	TAD 2RP 2M4	39,10 m	32,90 m
	TAD 2RG 4M3	> 39,10 m	> 32,90 m

# TRANSPORTATION

Transport · Transport · Transporte · Trasporto · Transporte · Транспортировка

## Packing list

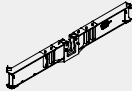
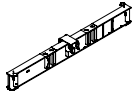
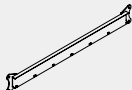
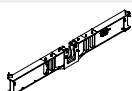
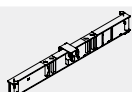
### Undercarriage

CTT 182-8	DESCRIPTION · BESCHREIBUNG · DESCRIPTION · DESCRIPCIÓN · DESCRIZIONE · DESCRIÇÃO · ОПИСАНИЕ	LENGTH · LÄNGE · LONGUEUR · LONGITUD · LUNGHEZZA · COMPRIMENTO · ДЛИНА	WIDTH · BREITE · LARGEUR · ANCHURA · LARGHEZZA · LARGURA · ШИРИНА	HEIGHT · HÖHE · HAUTEUR · ALTURA · ALTEZZA · ALTURA · ВЫСОТА	QUANTITY · MENGE · QUANTITÉ · CANTIDAD · CANTIDAD · QUANTITÀ · QUANTIDADE · КОЛИЧЕСТВО	WEIGHT · GEWICHT · PESO · PESO · PESO · ВЕС
	BEAM "A" FOR UNDERCARRIAGE C45 TS21-TS16	6,80 m	0,40 m	1,00 m	1	2820 kg
	BEAM "B" FOR UNDERCARRIAGE C45 TS21-TS16	6,80 m	0,75 m	0,80 m	1	2620 kg
	CROSSBEAMS UNDERCARRIAGE C45 TS21-TS16	4,40 m	0,12 m	0,54 m	2	230 kg
	"A" BEAM FOR UNDERCARRIAGE C60	8,90 m	0,40 m	1,10 m	1	3600 kg
	"B" BEAM FOR UNDERCARRIAGE C60	8,90 m	0,70 m	0,90 m	1	3600 kg
	CROSSBEAM FOR UNDERCARRIAGE C60	5,90 m	0,60 m	0,20 m	2	450 kg

### Tower

	TS21 22.3 TOWER SECTION	2,10 m	2,10 m	2,98 m	1	1382 kg*
	TS21 22.6 TOWER SECTION	2,10 m	2,10 m	5,93 m	1	2550 kg*
	TS21 22.12 TOWER SECTION	2,07 m	2,10 m	11,80 m	1	4825 kg
	TS21 22.6 C1 TOWER SECTION	2,10 m	2,10 m	5,93 m	1	2800 kg*
	TS21 22.6 C2 TOWER SECTION	2,10 m	2,10 m	5,93 m	1	2611 kg*
	TS21 22.6 CL1 TOWER SECTION	2,10 m	2,10 m	5,90 m	1	3320 kg
	SLEWING UNIT COMPLETE TS21	2,50 m	2,20 m	4,56 m	1	7000 kg

## Cab

CTT 182-8	DESCRIPTION · BESCHREIBUNG · DESCRIPTION · DESCRIPCIÓN · DESCRIZIONE · DESCRIÇÃO · ОПИСАНИЕ	LENGTH · LÄNGE · LONGUEUR · LONGITUD · LUNGHEZZA · COMPRIMENTO · ДЛИНА	WIDTH · BREITE · LARGEUR · ANCHURA · LARGHEZZA · LARGURA · ШИРИНА	HEIGHT · HÖHE · HAUTEUR · ALTURA · ALTEZZA · ALTURA · ВЫСОТА	QUANTITY · MENGE · QUANTITÉ · CANTIDAD · QUANTITÀ · QUANTIDADE · КОЛИЧЕСТВО	WEIGHT · GEWICHT · POIDS · PESO · PESO · ВЕС
	CAB EVO 15	3,20 m	2,00 m	2,30 m	1	1190 Kg

## Upper Part



	COUNTERJIB COMPLETE	9,70 m	1,35 m	0,80 m	1	2240 kg
	JIB POINT SECTION	0,90 m	1,30 m	1,10 m	1	70 kg
	JIB SECTION-30 COMPLETE (TROLLEY AND HOIST BLOCK)	11,90 m	2,00 m	2,80 m	1	6800 kg**
	JIB TROLLEY AND HOIST BLOCKS	1,35 m	1,60 m	0,90 m	1	723 kg
	ELECTRICAL BOX PLATFORM	2,39 m	1,59 m	1,78 m	1	770 kg
	BALLAST BASKET	1,20 m	0,75 m	2,70 m	1	265 kg
	JIB SECTION-23	10,30 m	1,11 m	2,20 m	1	2161 kg
	JIB SECTION-24	10,30 m	1,11 m	2,20 m	1	1650 kg
	JIB SECTION-25	10,30 m	1,11 m	1,83 m	1	1400 kg
	JIB SECTION-5	5,22 m	1,11 m	1,80 m	1	530 kg
	JIB SECTION-6	5,20 m	1,11 m	1,80 m	1	510 kg
	JIB SECTION-7	5,20 m	1,11 m	1,30 m	1	450 kg
	JIB SECTION-8	5,20 m	1,11 m	1,30 m	1	410 kg

\* Inclusive of ladder, ladder support and protection, platform

\*\* rope excluded

# TRANSPORTATION

Transport · Transport · Transporte · Trasporto · Transporte · Транспортировка

CTT 182-8	DESCRIPTION · BESCHREIBUNG · DESCRIPTION · DESCRIPCIÓN · DESCRIZIONE · DESCRIÇÃO · ОПИСАНИЕ	LENGTH · LÄNGE · LONGUEUR · LONGITUD · LUNGHEZZA · COMPRIMENTO · ДЛИНА	WIDTH · BREITE · LARGEUR · ANCHURA · LARGHEZZA · LARGURA · ШИРИНА	HEIGHT · HÖHE · HAUTEUR · ALTURA · ALTEZZA · ALTURA · ВЫСОТА	QUANTITY · MENGE · QUANTITÉ · CANTIDAD · QUANTITÀ · QUANTIDADE · КОЛИЧЕСТВО	WEIGHT · GEWICHT · POIDS · PESO · PESO · ВЕС
	JIB SECTION-9	5,20 m	1,11 m	1,30 m	1	310 kg
	JIB SECTION-10	5,20 m	1,11 m	1,30 m	1	250 kg

# NOTES

CTT 182-8

Notizen · Note · Apunte · Appunti · Notas · Заметки

---

---

---

---

---

---

---

---

---

---

---

---

---

---

---

---

---

---

---

---

---

---

---





Effective Date: June 2015.

Product specifications and prices are subject to change without notice or obligation. The photographs and/or drawings in this document are for illustrative purposes only. Refer to the appropriate Operator's Manual for instructions on the proper use of this equipment. Failure to follow the appropriate Operator's Manual when using our equipment or to otherwise act irresponsibly may result in serious injury or death. The only warranty applicable to our equipment is the standard written warranty applicable to the particular product and sale and Terex makes no other warranty, express or implied. Products and services listed may be trademarks, service marks or trade-names of Terex Corporation and/or its subsidiaries in the USA and other countries. All rights are reserved. Terex® is a registered trademark of Terex Corporation in the USA and many other countries.

Gültig ab: Juni 2015.

Produktbeschreibungen und Preise können jederzeit und ohne Verpflichtung zur Ankündigung geändert werden. Die in diesem Dokument enthaltenen Fotos und/oder Zeichnungen dienen rein anschaulichen Zwecken. Anweisungen zur ordnungsgemäßen Verwendung dieser Ausrüstung entnehmen Sie bitte dem zugehörigen Betriebshandbuch. Nichtbefolgung des Betriebshandbuchs bei der Verwendung unserer Produkte oder anderweitig fahrlässiges Verhalten kann zu schwerwiegenden Verletzungen oder Tod führen. Für dieses Produkt wird ausschließlich die entsprechende, schriftlich niedergelegte Standardgarantie gewährt. Terex leistet keinerlei darüber hinaus gehende Garantie, weder ausdrücklich noch stillschweigend. Die Bezeichnungen der aufgeführten Produkte und Leistungen sind gegebenenfalls Marken, Servicemarken oder Handelsnamen der Terex Corporation und/oder ihrer Tochtergesellschaften in den USA und anderen Ländern. Alle Rechte vorbehalten. „TEREX“ ist eine eingetragene Marke der Terex Corporation in den USA und vielen anderen Ländern.

Date d'effet : Juin 2015.

Les spécifications et prix des produits sont sujets à modification sans avis ou obligation. Les photographies et/ou dessins contenus dans ce documents sont uniquement pour illustration. Veuillez vous référer à la notice d'utilisation appropriée pour les instructions quant à l'utilisation correcte de cet équipement. Tout manquement au suivi de la notice d'utilisation appropriée lors de l'utilisation de notre équipement ou tout acte autrement irresponsable peut résulter en blessure corporelle sérieuse ou mortelle. La seule garantie applicable à notre équipement est la garantie standard écrite applicable à un produit et à une vente spécifique. Terex n'offre aucune autre garantie, expresse ou implicite. Les produits et services proposés peuvent être des marques de fabrique, des marques de service ou des appellations commerciales de Terex Corporation et/ou ses filiales aux Etats Unis et dans les autres pays, et tous les droits sont réservés. «TEREX» est une marque déposée de Terex Corporation aux Etats Unis et dans de nombreux autres pays.

Fecha efectiva: Junio 2015.

Los precios y las especificaciones de productos pueden sufrir cambios sin aviso previo u obligación. Las fotografías o dibujos de este documento tienen un fin meramente ilustrativo. Consulte el manual de instrucciones del operador correspondiente para más información sobre el uso correcto de este equipo. El hecho de no respetar el manual del operador correspondiente al utilizar el equipo o actuar de forma irresponsable puede suponer lesiones graves o fatales. La única garantía aplicable a nuestro equipo es la garantía escrita estándar correspondiente a cada producto y venta, y TEREX no amplía dicha garantía de forma expresa o implícita. Los productos y servicios mencionados pueden ser marcas registradas, marcas de servicio o nombres de marca de TEREX Corporation o de sus filiales en Estados Unidos de América y otros países, y se reservan todos los derechos. „TEREX“ es una marca comercial registrada de Terex Corporation en Estados Unidos de América y muchos otros países.

Data di inizio validità: Giugno 2015.

Ci riserviamo il diritto di modificare le specifiche e i prezzi dei prodotti in ogni momento e senza preavviso. Le fotografie e/o i disegni contenuti in questo documento sono destinati unicamente a scopi illustrativi. Consultare le istruzioni sull'uso corretto di questo macchinario, contenute nell'opportuno Manuale dell'operatore. L'inottemperanza delle istruzioni contenute nel Manuale dell'operatore del macchinario e altri comportamenti irresponsabili possono provocare gravi lesioni, anche mortali. L'unica garanzia applicabile ai nostri macchinari è la garanzia scritta standard applicabile al particolare prodotto e alla particolare vendita; Terex è esonerata dal fornire qualsiasi altra garanzia, esplicita o implicita. I prodotti e servizi elencati possono essere dei marchi di fabbrica, marchi di servizio o nomi commerciali di TEREX Corporation e/o società affiliate negli Stati Uniti d'America e altre nazioni e tutti i diritti sono riservati. „TEREX“ è un marchio registrato di Terex Corporation negli USA e molti altri Paesi.

Data de vigência: Junho 2015.

Especificações e preços dos produtos sujeitos a alteração sem aviso prévio ou obrigações. As fotografias e/ou desenhos deste documento servem apenas para fins ilustrativos. Consulte o respectivo Manual de Instruções para instruções sobre o uso correto deste equipamento. A falta de atenção ao respectivo Manual do Operador no uso de nosso equipamento ou a operação da máquina em condições impróprias pode resultar em lesão grave ou morte. A única garantia aplicável aos nossos equipamentos é a garantia padrão por escrito, aplicável ao produto específico e à sua venda, sem que nenhuma outra, expressa ou implícita, seja oferecida pela Terex. Os produtos e serviços listados podem ser marcas comerciais, marcas de serviço ou nomes-fantasia da Terex Corporation e/ou suas subsidiárias nos EUA e em outros países. Todos os direitos reservados. Terex® é marca registrada da Terex Corporation nos EUA e muitos outros países.

Вступает в силу: Июнь 2015.

Технические характеристики и цены могут изменяться без предварительного уведомления и без каких-либо обязательств для производителя. Фотографии и (или) чертежи, использованные в документе, приведены исключительно в качестве иллюстраций. Инструкции по правилам эксплуатации даются в соответствующих руководствах для операторов данного оборудования. Невыполнение рекомендаций руководства по эксплуатации нашего оборудования или другие безответственные действия могут повлечь серьезные травмы или смерть. Единственной гарантией, действующей в отношении нашего оборудования, является стандартная форма письменной гарантии на данный тип оборудования и на условия его продажи.



Copyright 2015 Terex Corporation

Terex Cranes, Global Marketing, Dinglerstraße 24, 66482 Zweibrücken, Germany  
Tel. +49 (0) 6332 830, Email: info.cranes@terex.com, www.terexcranes.com

Brochure Reference: TC-DS-M-E/F/G//S/P/R-CTT182-8-06/15

[www.terexcranes.com](http://www.terexcranes.com)



WORKS FOR YOU.™